

II. DEVELOPMENT PLAN

A. Land Use

The primary objective of the Mountain Park Specific Plan is to create a unique residential community surrounded by preserved ridgelines, wetlands, habitat and other open space. The Mountain Park Specific Plan allows the development of up to 2,500 dwelling units in seven development areas. The Development Plan (Exhibit 3) shows the spatial and symbolic relationship of Mountain Park's land uses. The project area has been divided into numbered "Development Areas". The development area boundaries coincide with general plan land use categories. Land use, roadway alignments and development designations are conceptual and not intended to represent precise boundary lines. Development area boundaries may be modified in accordance with the provisions of Section III, Zoning and Development Standards.

The approximate number of dwelling units within each residential development area is shown on Table A, Development Plan Statistical Summary. All references to acres, including density standards such as dwelling units per acre, are intended to mean gross acres as defined in Section III, Zoning and Development Standards.

Dwelling units in residential development areas as shown in Table A, Development Plan Statistical Summary, may be transferred to other Development Areas in accordance with Section III, Zoning and Development Standards.

1. Development Areas

Development areas 1, 2, 4, 5 and 6 are located east of SR-241 and Development Areas 3 and 7 are located west of SR-241. The development areas encompass 830 acres and are generally located in the northern portion of the project site. Development Areas 1, 2, 3 and 7 consist of Low-Medium Hillside Density Residential land uses which allow up to six dwelling units per acre, and Development Areas 4 and 5 consist of Low-Medium Density Residential land uses which allow up to 16 dwelling units per acre. Specific land use standards contained in the Mountain Park Specific Plan regulate the development of residential uses. Conceptual characteristics of each planning area are described below.

- a. Development Area 1 is the southernmost development area in the eastern portion of the project site. There are 210 single-family detached dwelling units proposed. The size of the lots is currently estimated to range from approximately 5,000 to 7,000 square feet. Access to this development area would be provided from the extension of Gypsum Canyon Road.
- b. Development Area 2 is located in the eastern portion of the project site. 130 single-family detached dwelling units are planned within this area, and access would be provided from the extension of Gypsum Canyon Road. The size of the lots is currently estimated to range from approximately 4,000 to 5,000 square feet.
- c. Development Area 3 is located west of SR-241, north of the proposed extension of Weir Canyon Road, and is proposed to include 50 single-family detached dwelling units. The size of the lots is proposed to range from approximately 3,375 to 4,000 square feet. A 15-acre community park and 10-acre school site are proposed within this area. Access to residential uses within the development area would be provided from Mountain Park Drive, a proposed new roadway within the project site.
- d. Development Area 4 is located in the northern portion of the site, adjacent to and east of SR-241. This development area is proposed to include 420 single-family detached dwelling units; access would be provided from Mountain Park Drive.
- e. Development Area 5 is located in the northeast portion of the project site and is proposed to include 1,595 single-family detached and single-family attached residential units. Access to this development area would be provided from Mountain Park Drive. A private recreation center is located southwest of the intersection of Gypsum Canyon Road/Mountain Park Drive, adjacent to Gypsum Creek.

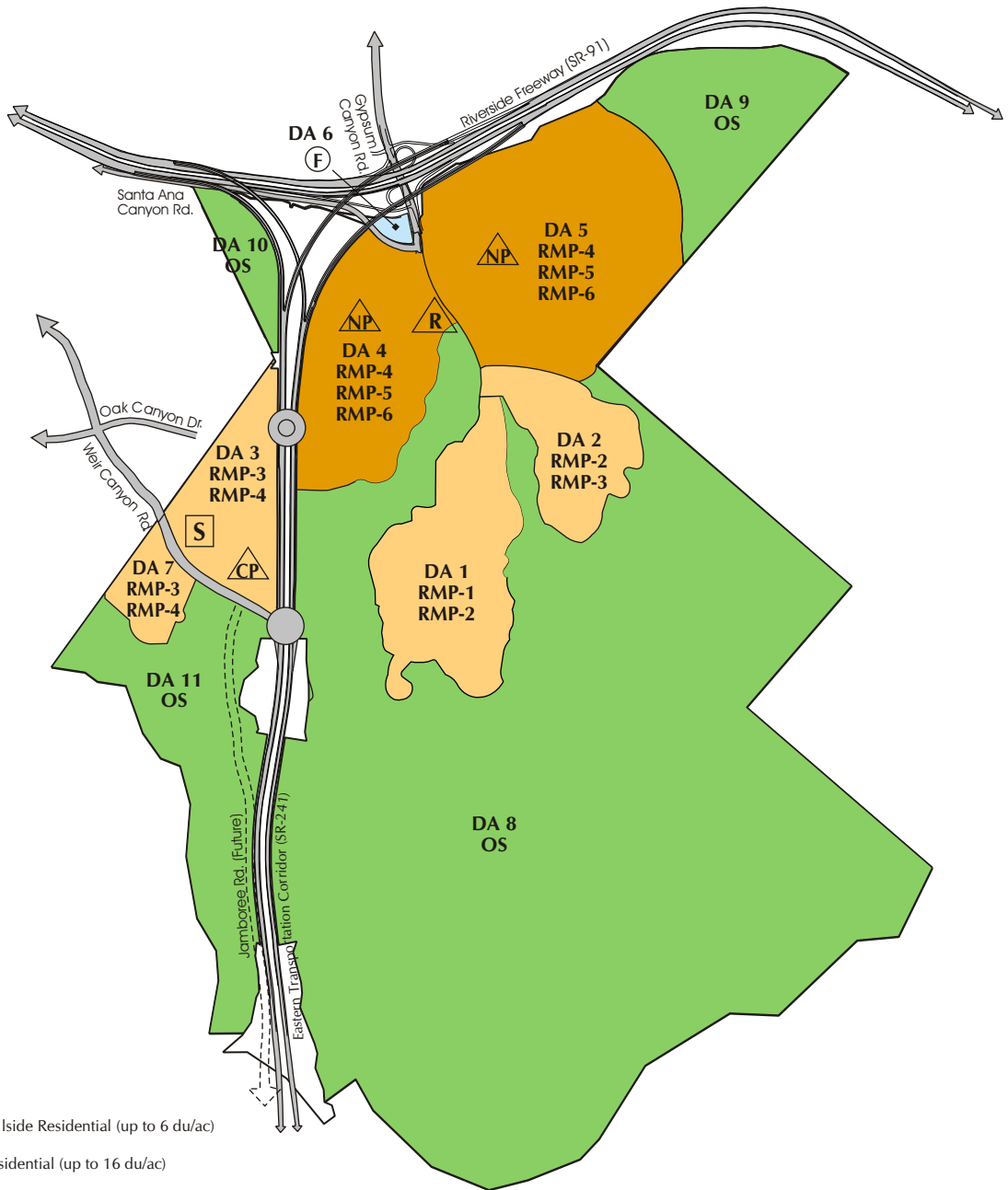

Legend

- Low-Medium Hillside Residential (up to 6 du/ac)
- Low-Medium Residential (up to 16 du/ac)
- Open Space
- Institutional
- S School
- F Fire Station
- CP Public Community Park
- NP Private Neighborhood Park
- R Private Recreation Center
- DA 5** Development Area
- RMP-4** Implementation Zone

Development Plan

Mountain Park Specific Plan (SP90-4, Amendment No. 1)

Exhibit 3

March 11, 2005



Not To Scale

**Table A
DEVELOPMENT PLAN STATISTICAL SUMMARY**

General Plan Land Use Designation	Maximum Intensity	Development Area	Applicable Zoning Districts	Acres ^E	SFD Dwelling Units ^F	SFA Dwelling Units ^F	Total DU
Low-Medium Hillside Density Residential (up to 6 du/ac)	485 dwelling units	1	RMP-1, RMP-2	161	210 ^A	0	210
		2	RMP-2, RMP-3	87	130	0	130
		3	RMP-3, RMP-4	88 ^B	50	0	50
		7	RMP-3, RMP-4	36	95	0	95
		Sub-Total			372	485	0
Low Medium Density Residential (up to 16 du/ac)	2,015 dwelling units	4	RMP-4, RMP-5, RMP-6 ^G	163	420	0	420
		5	RMP-4, RMP-5, RMP-6	291	770	825	1,595
		Sub-Total			454	1,190	825
Institutional	0.20 FAR	6	Special Purpose	5 ^C			
Sub-Total				5 ^C			
Open Space	0.10 FAR	8	Open Space/ Recreation	1,772			
		9		143			
		10		33			
		11		215			
		Sub-Total			2,163		
Public Highways (Weir Canyon Road, Santa Ana Canyon Road and a segment of Gypsum Canyon Road)				7			
Sub-Total				7			
GRAND TOTAL				3,001	1,675	825^D	2,500

^A At least forty (40) percent of the dwelling units in DA 1 shall be developed in an RMP-1 zone.

^B A ±10-acre school site and ±15-acre community park are included.

^C Fire Station acres are included.

^D No more than thirty-three (33) percent of the total dwelling units constructed in Mountain Park may be SFA.

^E SR-91 and SR-241 rights-of-way are not a part of the specific plan.

^F Up to 250 dwelling units may be transferred among development areas in accordance with Section 18.112.050.

^G In DA 4 no SFA units in the RMP-6 zone are shown; however, such units would be allowed if transferred into DA 4 in accordance with Section 18.112.050.

- f. Development Area 6 is located at the northwest corner of Santa Ana Canyon Road and Gypsum Canyon Road and will include, but not be limited to, a fire station, trail staging area, and 3,000 sq. ft. convenience store.
- g. Development Area 7 is located south of the proposed Weir Canyon Road extension, west of SR-241. This area is proposed to include 95 single-family detached dwelling units; access would be provided from the proposed extension of Weir Canyon Road. The size of the lots is currently estimated to range from approximately 3,375 to 4,000 square feet.

2. Regional Open Space

The open space and recreation components of the project are part of The Irvine Company's approximate 50,000-acre Irvine Ranch Land Reserve (IRLR). The IRLR includes the open space areas within the Irvine Ranch property, including but not limited to: The Irvine Company lands (approximately 21,000 acres) within the County of Orange Central & Coastal Subregion NCCP Natural Communities Conservation Plan & Habitat Conservation Plan Reserve (NCCP/HCP Reserve); over 11,000 acres of area within conservation easements; various wildlife and marine preserves; open space; recreational preserves; and cultural and educational facilities. The primary goals of the IRLR are to further protect and preserve its sensitive resources, and to provide new and diverse recreational access to the public.

The proposed project includes the following open space components which are depicted on Exhibit 4 and described below: 940 acres within the NCCP/HCP Reserve; 911 acres within The Nature Conservancy Anaheim Conservation Easement (TNC ACE); and 312 acres of other open space.

a. NCCP/HCP Reserve

The NCCP/HCP was adopted by the California Department of Fish and Game (CDFG), U.S. Fish and Wildlife Service (USFWS), and participating agencies (including the City of Anaheim) in 1996, five years after certification of the Mountain Park Specific Plan (SP 90-04) Final EIR (FEIR No. 302), to address protection and management of coastal sage scrub (CSS) habitat and CSS-obligate species, and other covered habitats and species, including oak woodlands and Tecate Cypress. The NCCP/HCP mitigates anticipated impacts to those habitats and species on a programmatic, sub-regional level, rather than on a project-by-project, single species basis. The NCCP/HCP involved the establishment of an approximate 37,000-acre Reserve for the protection of CSS, other upland habitats, the coastal California gnatcatcher, and other species identified in the NCCP/HCP. As noted above, 940 acres of the project site are within the NCCP/HCP Reserve and are protected by the provisions of that program. The Mountain Park development areas are specifically authorized to be developed under the NCCP/HCP.

Following approval of the NCCP/HCP, the participating agencies (including the City of Anaheim) and participating landowners (including The Irvine Company), USFWS, CDFG, and the County of Orange signed an Implementation Agreement (IA). The IA sets forth the implementation requirements for the NCCP/HCP, including requirements related to dedication, creation, and management of the Reserve, interim management of the Reserve, funding for Reserve management, and procedures and minimization measures related to development impacts to, and "take" of Identified Species and modification of habitat in those areas designated for development under the NCCP/HCP.

The Nature Reserve of Orange County (NROC), a non-profit corporation was formed in December 1996. The NROC Board of Directors includes participating landowners, agencies and environmental groups and is responsible for adaptive management coordination functions concerning the NCCP/HCP Reserve, including: policies for managing and monitoring of the Reserve, research, habitat restoration and enhancement, fire management, public access, permitting of infrastructure, existing uses and interim management, all as specified in the NCCP/HCP; managing the endowment received from the participating landowners and agencies and any in-lieu mitigation fees that are collected from non-participating entities; and preparing and approving an annual report for submittal to CDFG and USFWS.

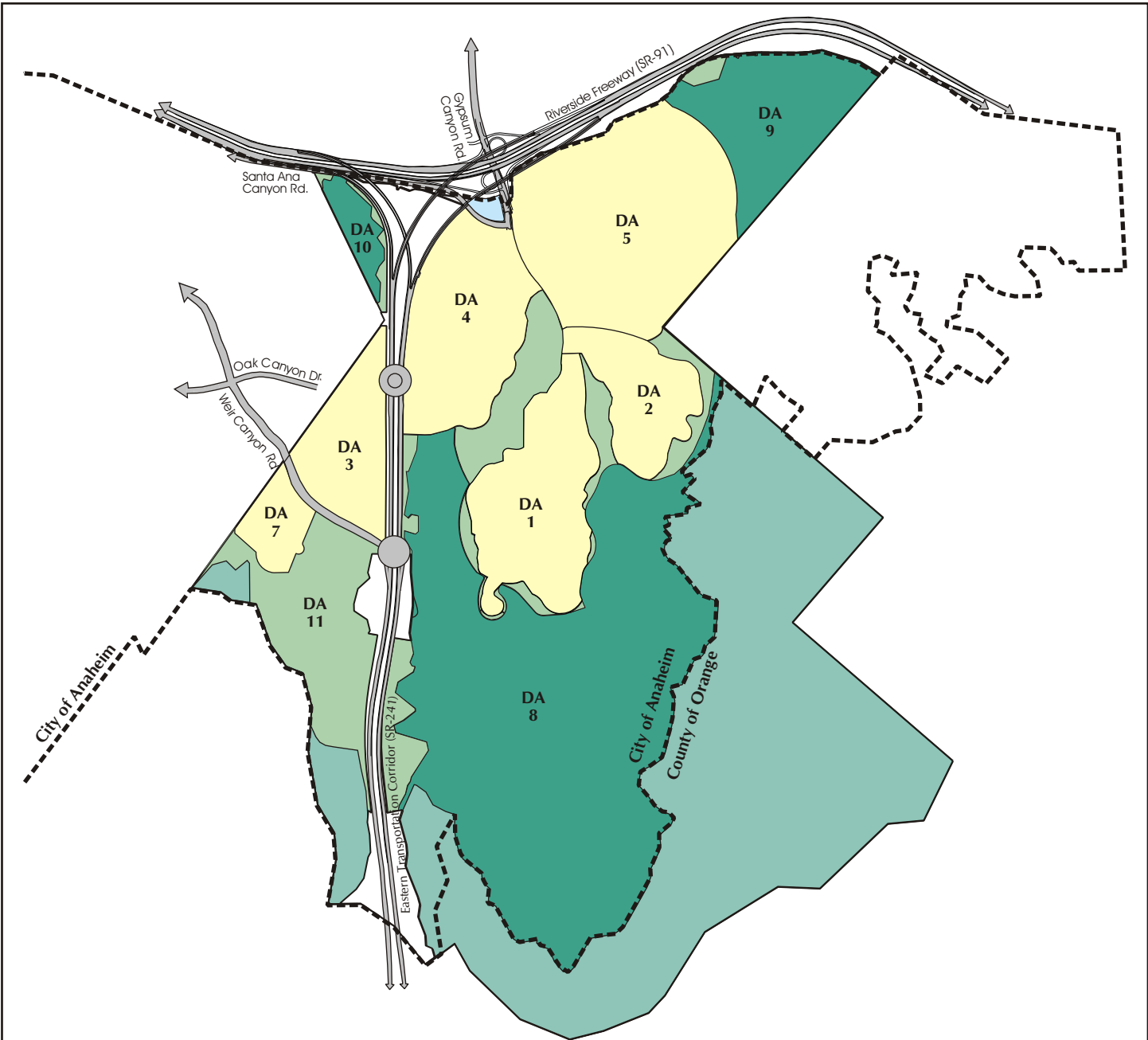

Legend

- Other Open Space (312 Acres)
- Natural Communities Conservation Plan Reserve (940 acres)
- The Nature Conservancy Anaheim Conservation Easement (911 acres)
- Development Areas

Total Open Space Acres = 2,163

Open Space Plan

Mountain Park Specific Plan (SP90-4, Amendment No. 1)

Exhibit 4

March 11, 2005



Not To Scale

Each landowner is required to manage its property within the Reserve pursuant to the provisions of the IA, as outlined in the NCCP/HCP. The Irvine Company, a participating landowner in the NCCP/HCP, commissioned The Nature Conservancy (TNC) to manage its wildland open space within the NCCP/HCP boundaries, including areas within the Reserve. The TNC manages the NCCP/HCP Reserve areas within the Mountain Park site.

b. The Nature Conservancy Anaheim Conservation Easement

In November 2001, The Irvine Company dedicated 11,000 acres to the TNC in the form of conservation easements, including The Nature Conservancy Anaheim Conservation Easement (TNC ACE). The TNC ACE is within the Mountain Park project site and includes 911 acres within three parcels. When the conservation easements were dedicated, agreements were made between The Irvine Company and The Nature Conservancy regarding permitted and prohibited uses. Any activities within the TNC ACE area must be coordinated with The Nature Conservancy. Uses permitted in the conservation easement areas that are relevant to the proposed project include: existing roads and trails; environmental enhancement activities; passive recreational activities; and limited slope stabilization and infrastructure activities needed to support development. These permitted uses are subject to specific provisions outlined in the TNC ACE and approval of The Nature Conservancy.

c. Other Open Space

The remainder of the open space within the Mountain Park Project site (approximately 312 acres) is classified as “other open space” and will be owned and maintained by the project’s Homeowner’s Association and/or other entities. The areas would consist of passive open space and amenities including trails.

3. Parks

The Mountain Park Specific Plan includes one public community park site to satisfy the City of Anaheim park requirements. Private parks will be developed in Development Areas 4 and 5 and will not receive credit for meeting the City’s park requirement. A public community park, private neighborhood parks and a private recreation center are symbolically shown on Exhibit 3, Development Plan. The actual location, size and configuration within the development area will be determined with subdivision approvals.

- a.** An approximate 15-acre public community park is proposed within Development Area 3. Specific facility size and improvements to the community park will be determined in coordination with the City of Anaheim, Community Services Department as part of subsequent tentative tract map and park plan approvals; however, it is expected that the following would be provided: community center building, open turf for open play, tennis courts, basketball courts, softball fields, soccer/football field, and picnic and gathering facilities. The Sportsfields will be lighted to meet the youth and adult sports league purposes. Security lighting will also be provided.
- b.** A private recreation center is proposed in Development Area 5 and adjacent to Gypsum Canyon Creek. Amenities that may be provided at this facility include: swimming pool and spa; community room; courtyard and terrace; tot lot; turf areas; and parking. This recreation center would be owned and managed by the future Homeowner’s Association and would be available to all residents within the Mountain Park Specific Plan area.
- c.** Private neighborhood parks are proposed within Development Areas 4 and 5.

4. Public Trails

The Specific Plan includes regional bikeways and riding and hiking trails, which are conceptually shown on Exhibit 5, Public Trail Plan.

a. Gypsum Canyon Creek Riding and Hiking Trail

A public regional riding and hiking trail will be located generally along Gypsum Canyon Creek in DA 6, 4, 5 and 1 within tract or parcel map boundaries. This trail would be constructed to County of Orange standards and would be maintained by the County of Orange or a Homeowners Association.

A trail staging area will be dedicated and constructed by the property owner/developer in Development Area 6 to be maintained by the City of Anaheim.

b. Public Bikeways

The proposed conceptual public bikeway plan for the project is presented on Exhibit 5. The objective of plan is to provide an on-road bikeway from Santa Ana Canyon Road and Featherly Regional Park through the project via Mountain Park Drive, and connect to Weir Canyon Road. These specific bikeways will be public facilities; other private bikeways will be provided on private roads.

A Public Class II on-road bikeway will be located on the following roadways within the project:

Santa Ana Canyon Road	(from project boundary to Gypsum Canyon Road)
Gypsum Canyon Road	(from the Class 1 off-road bikeway in Featherly Regional Park to Mountain Park Drive)
Mountain Park Drive	(from Gypsum Canyon Road to Weir Canyon Road)
Weir Canyon Road	(from Mountain Park Drive to project boundary)

5. Schools

The Mountain Park project is within the boundaries of the Orange Unified School District (OUSD). The ultimate requirement for the school facility will be the subject of a school mitigation agreement with OUSD.







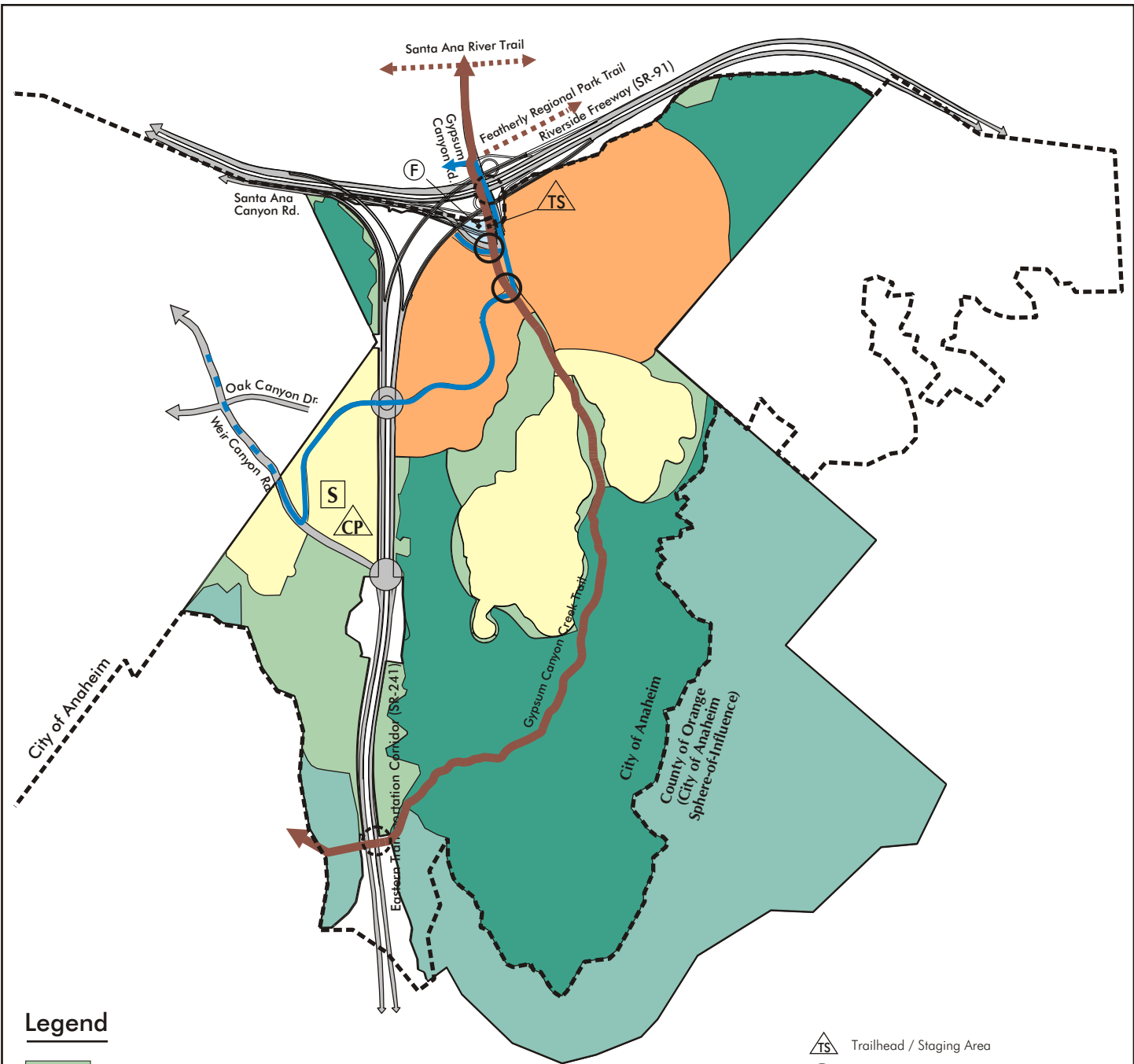











A school site is reserved for possible acquisition by the Orange Unified School District, consistent with OUSD’s areawide plans. The school site is shown symbolically on the Development Plan and will be precisely located and sized in connection with the processing of subdivision plans.

6. Fire Station

The Mountain Park project includes the dedication of land for construction of a fire station for the City of Anaheim, in Development Area 6. The fire station construction, timing and equipment shall be in accordance with an approved Fire Protection Agreement and Fire Department requirements.



Legend

- | | | | | | |
|-------------------------------------------------------------------------------------|------------------------------------------------------------------------------------------------|-------------------------------------------------------------------------------------|--------------------------------------------------------------|---------------------------------------------------------------------------------------|-----------------------------------------------|
|  | Other Open Space (310 Acres) |  | City of Anaheim Limits |  | Trailhead / Staging Area |
|  | NCCP/HCP Reserve (Natural Communities Conservation Plan/Habitat Conservation Plan) (940 acres) |  | Proposed Riding, Hiking, Pedestrian and Mountain Bike Trail* |  | Existing Undercrossings |
|  | TNC ACE (The Nature Conservancy Anaheim Conservation Easement) (913 acres) |  | Existing Regional Riding & Hiking Trail |  | Proposed Riding & Hiking Trail Undercrossings |
|  | Institutional |  | Proposed On-Road City Bikeway (Class II) |  | School |
|  | Low-Medium Density Residential |  | Existing On-Road Bikeway (Class II) |  | Fire Station |
|  | Low-Medium Hillside Density Residential | | |  | Community Park |
| | | | |  | Toll Road Overcrossing |
| | | | |  | Toll Road Interchange |

Total Open Space Acres = 2,163

* Referred to as Proposed Regional Riding & Hiking Trail per County Standards

Public Trail Plan

Mountain Park Specific Plan (SP90-4, Amendment No. 1)

Exhibit 5

March 11, 2005



Not To Scale

B. Circulation

The goal of the Vehicular Circulation Plan as shown on Exhibit 6, is to provide a circulation system that has sufficient capacity to meet the transportation demands generated by development of the Mountain Park project. The following circulation features have been incorporated into the Mountain Park Specific Plan to accomplish this goal.

- 1. Roadway Classifications.** The street standards for each roadway classification on the circulation plan are set forth in Exhibits 7A through 7D and shall apply to Mountain Park. In addition to the arterials and streets identified above, the project would also include a network of interior streets. The street sections conform to Department of Public Works Standards except that sidewalks have been omitted along segments that do not lead to residential units and privately maintained medians have been added on Mountain Park Drive and Gypsum Canyon Road to enhance aesthetics.

**Table B
ROADWAY CLASSIFICATION INDEX**

ROADWAY	CLASSIFICATION	INTERIOR SPECIFIC PLAN SECTIONS	EXHIBIT NO.
Gypsum Canyon Road (Public) – between SR-91 and Santa Ana Canyon Road	Hillside Primary-Four Lanes (modified)	C & J	7B & 7D
Gypsum Canyon Road (Private)- between SR-91 and Santa Ana Canyon Rd.	Hillside Primary-Four Lanes (modified)	D	7B
Weir Canyon Road (Public)	Hillside Secondary (modified)	A & B	7A
Santa Ana Canyon Road (Public)	Hillside Secondary (modified)	E	7B
Mountain Park Drive (Public & Private)	Hillside Collector (modified)	F & G	7C
Gypsum Canyon Road (Private)- south of gated entrance	Hillside Collector (modified)	H	7C
Streets “A” through “E” (Private)	Hillside Collector (modified)	H & I	7C & 7D

- 2. Gated Entries.** There are two entries into the project site: Gypsum Canyon Road and Weir Canyon Road. As part of the project, Gypsum Canyon Road will be extended south from its current terminus near Santa Ana Canyon Road and will terminate within Development Area 1. Manned guard gates will be provided on Gypsum Canyon Road and on Mountain Park Drive. Weir Canyon Road will be extended from its current terminus at Blue Sky Way to a proposed interchange at SR-241.
- 3. Bridge Structures.** Mountain Park Drive will bridge SR-241 to provide access between Development Areas east and west of SR-241. This overcrossing will be constructed at the same time as the portion of Mountain Park Drive on the east side of SR-241. The bridge is proposed to span 340 feet and would be a cast-in-place concrete box girder. The proposed cross-section for the bridge overcrossing is provided on Exhibit 7C.

A bridge structure will also be provided over Gypsum Creek along Gypsum Canyon Road. The Gypsum Canyon Creek bridge will accommodate one lane of traffic in each direction, a center median and a raised pedestrian sidewalk on one side of the bridge. The bridge would be 50 to 55 feet in width and would be approximately 200 feet long.

4. **Weir Canyon Road/SR-241 Interchange.** The interchange will be constructed by the property owner/developer as part of the project in a cooperative effort with the Foothill/Eastern Transportation Corridor Agencies (F/ETCA).
5. **Rolled Curbs.** To enhance the hillside character of Mountain Park, rolled curbs for parkways and medians will be standard on most private roadways. Exhibit 7E sets forth the standards for modified rolled curbs for private roads in Mountain Park. Rolled curbs will incorporate drain outlets subject to the approval of the Director of Public Works.
6. **Interior Streets and Courts.** The street standards for private hillside interior streets and private courts are set forth in Exhibits 7F and 7G. Alternative standards may be considered as part of a site plan approval to promote innovative residential design and unique site conditions subject to the approval of the Traffic and Transportation Manager.
7. **Mountable Medians.** A mountable/drivable fire emergency lane in the median of Gypsum Canyon Road into Development Areas 1 and 2, and the entrance to Development Areas 3 and 4. The median would be designed and maintained to support imposed loads of the Anaheim Fire Department apparatus.
8. **Meandering Sidewalks.** Public sidewalks may meander outside the right-of-way onto Landscaped Setback owned by the Homeowners Association if the City is granted an easement.
9. **School/Park Access.** Vehicular access from Weir Canyon Road to the Park/School facility will be provided by a break in the median that will be designed to accommodate ingress to the facilities. Final design of vehicular access to the school/park site will be determined as part of the design of these facilities.
10. **Traffic Calming Features.** Traffic calming features, including: “street chokers” (curb extensions) that reduce the curb-to-curb dimension and do not allow for on-street parking; a 4-way roundabout at the intersection of Gypsum Canyon Road and Mountain Park Drive; and “knuckles” (turns in the road that do not allow for street parking). All of these features would be designed to meet fire truck turning radius requirements. Conceptual diagrams of these circulation features are provided in Exhibits 7H through 7J.

C. **Housing and Population**

The housing program for Mountain Park provides a variety of residential product types to meet the future demand for housing in the region. The program provides 2,500 net new single-family detached and attached dwelling units in a variety of settings with a minimum of education, safety and recreation jobs within a jobs-rich subregion and a jobs-rich city. While both the city and subregion will remain jobs-rich in 2025, the project lessens the degree to which they will be jobs-rich by providing a substantial number of housing units with little added employment.

It is estimated that Mountain Park’s housing program will yield a maximum of 2,500 dwelling units resulting in a resident population of approximately 8,251 (using 3.3 persons/dwelling unit from the Anaheim General Plan, Land Use Element, Table LU-5).

D. **Community Design Guidelines**

The purpose of this section is to establish general guidelines that provide for an overall community character. These guidelines are intended to be used for general reference by the City of Anaheim as part of the development area plan, tentative tract or parcel map and site plan review processes. However, they are not intended to be used as minimum requirements. It is recognized that all guidelines need not be achieved for any given project.

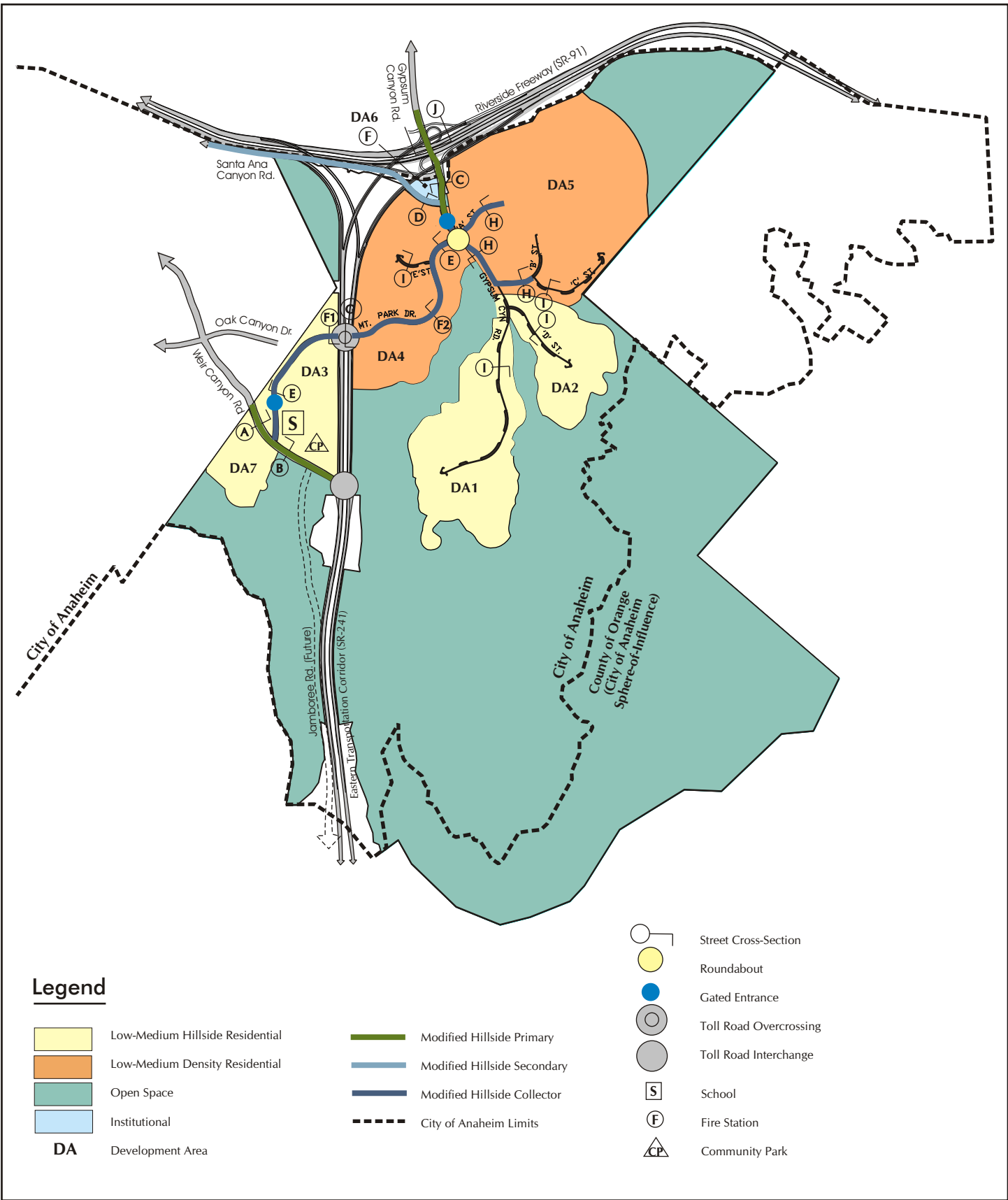

Vehicular Circulation Plan & Section Key Map

Mountain Park Specific Plan (SP90-4, Amendment No. 1)

Exhibit 6

March 11, 2005



Not To Scale

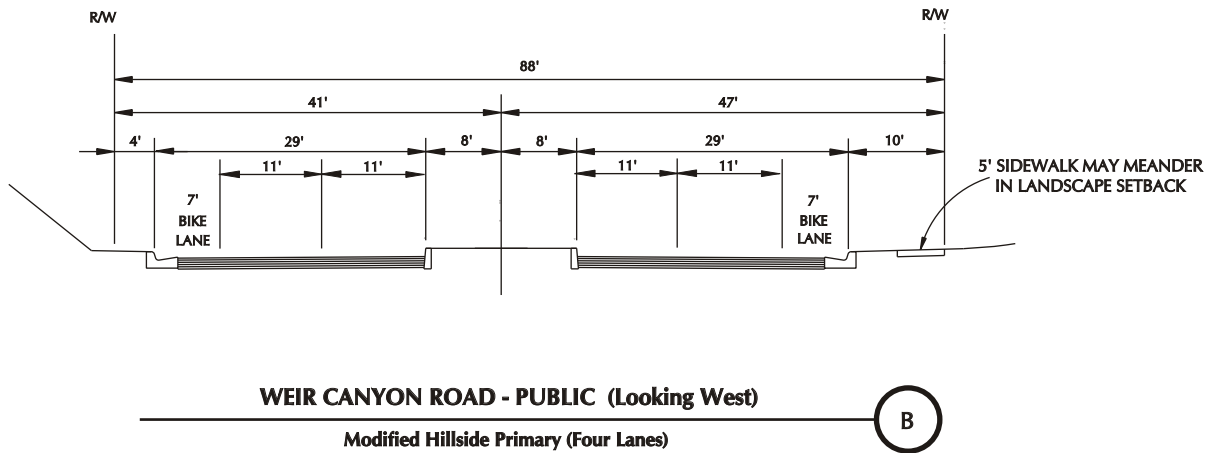
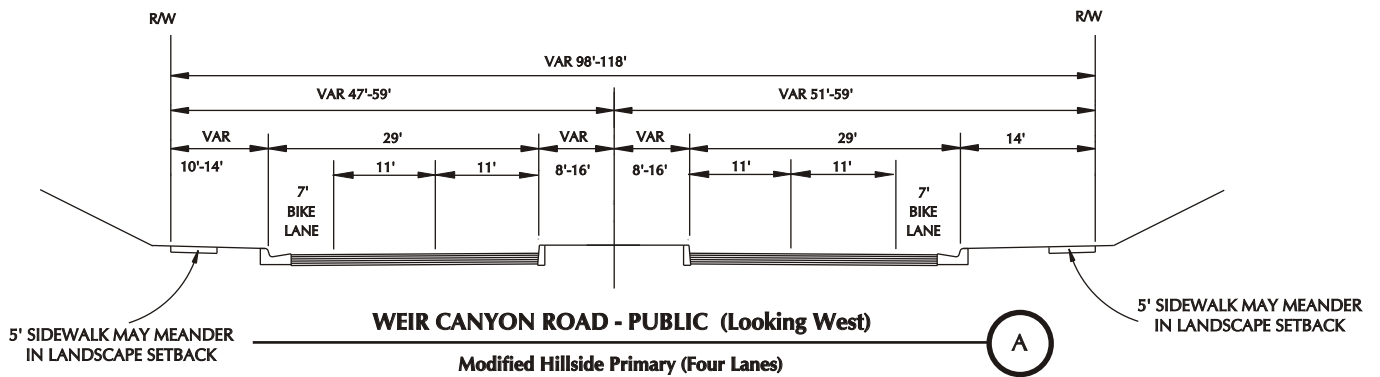

Road Sections A - B

Exhibit 7A

Mountain Park Specific Plan (SP90-4, Amendment No. 1)

March 11, 2005



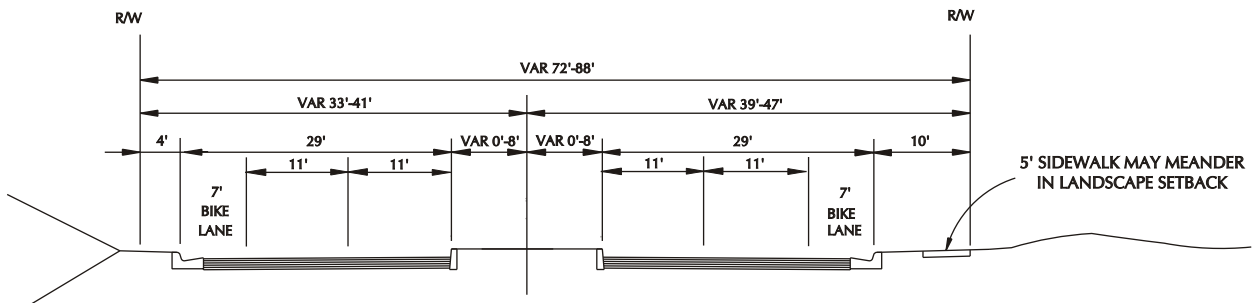

GYPSUM CANYON ROAD - PUBLIC (Looking South)

Modified Hillside Primary (Four Lanes)

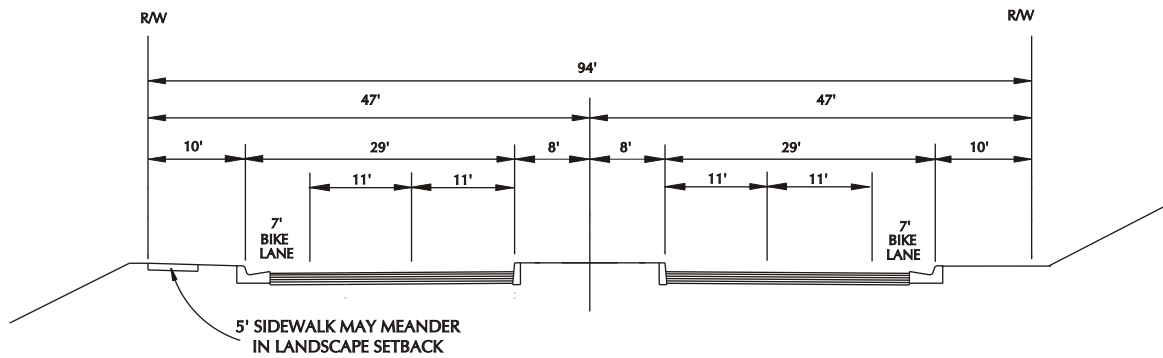

SANTA ANA CANYON ROAD - PUBLIC (Looking East)

Modified Hillside Secondary

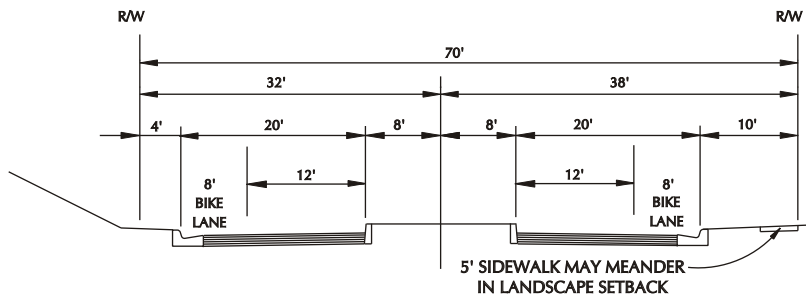

**MOUNTAIN PARK DRIVE - PUBLIC
(Looking North & East)**

Modified Hillside Collector



Road Sections C - E

Mountain Park Specific Plan (SP90-4, Amendment No. 1)

Exhibit 7B

March 11, 2005



Not To Scale

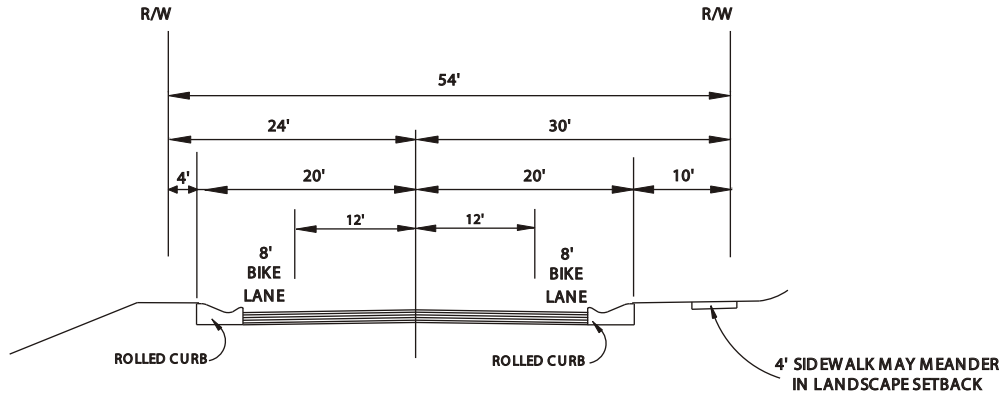

MOUNTAIN PARK DRIVE - PRIVATE (Looking North & East)

Modified Hillside Collector

F

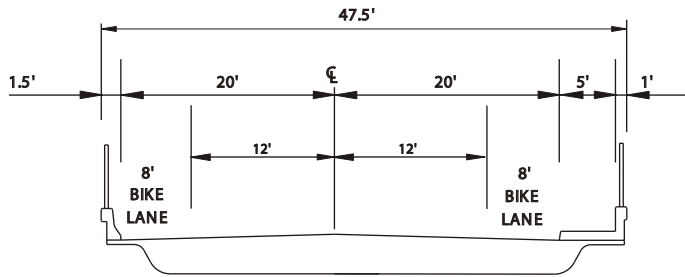

S.R. 241 BRIDGE OVERCROSSING - PRIVATE (Looking East)

G

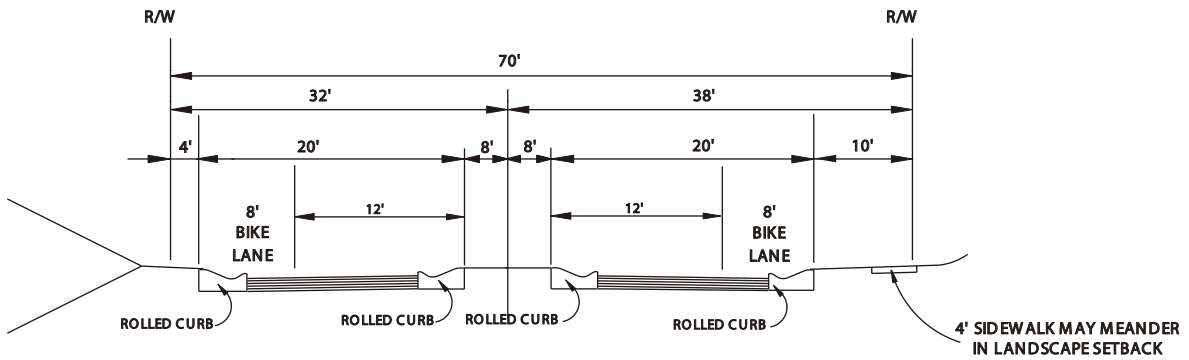

GYPSUM CANYON ROAD - PRIVATE (Looking South)

STREET "A" - PRIVATE (Looking East)

STREET "B" - PRIVATE (Looking East)

Modified Hillside Collector

H

Road Sections F - H

Mountain Park Specific Plan (SP90-4, Amendment No. 1)

Exhibit 7C

March 11, 2005



Not To Scale

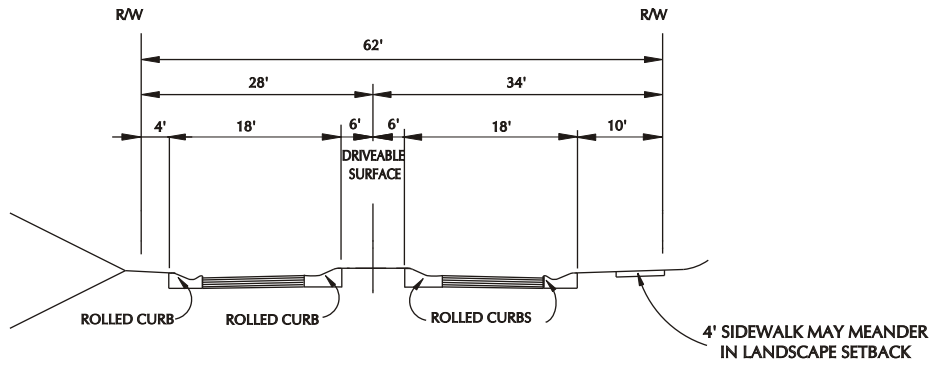

GYPSUM CANYON ROAD - PRIVATE (Looking South)

STREET "C" - PRIVATE (Looking East)

STREET "D" - PRIVATE (Looking East)

STREET "E" - PRIVATE (Looking West)

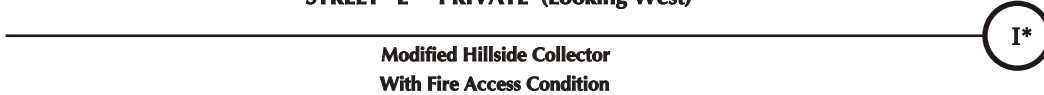

** Note: A driveable median is a paved median abutting a rolled curb. The pavement surface must support emergency vehicles and shall be approved by the Fire Department.*

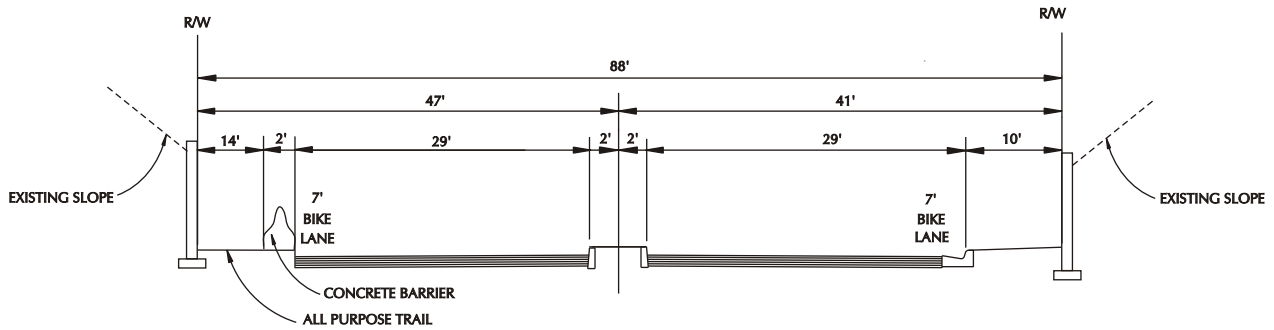

GYPSUM CANYON ROAD (Under SR-91 Freeway - Looking North)

Modified Hillside Primary (Four Lanes)



** Final design and ownership are subject to Caltrans / County approval*

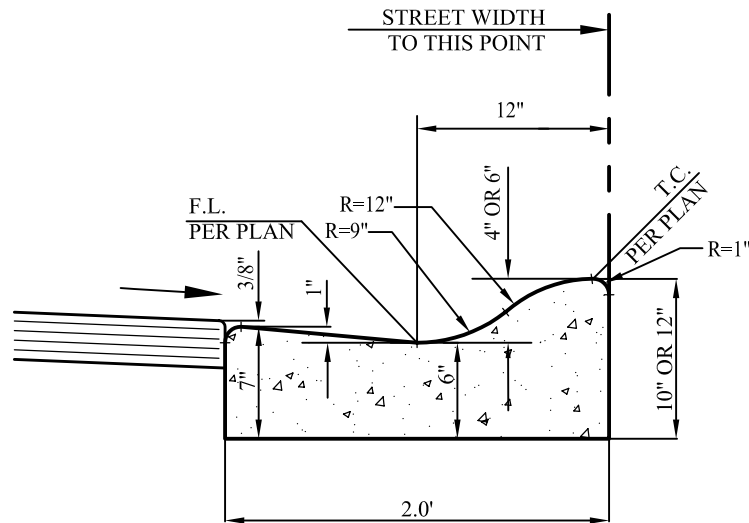

TYPE I MODIFIED ROLLED CURB AT PARKWAY (PRIVATE ROAD)

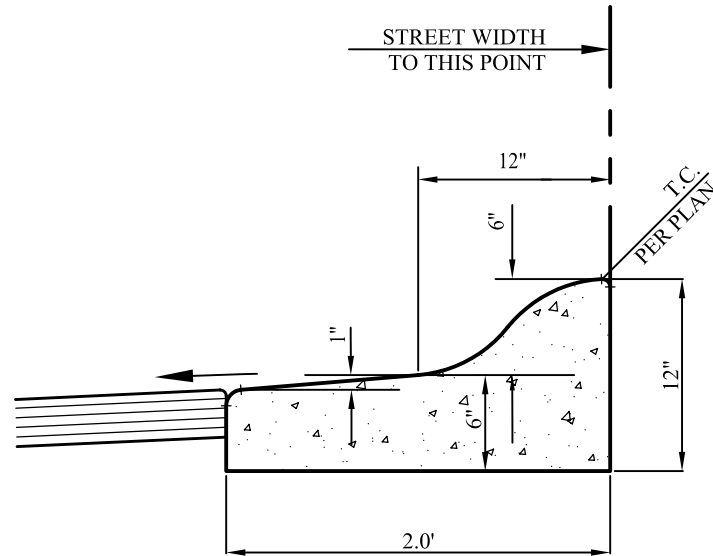

TYPE II MODIFIED ROLLED CURB AT MEDIAN (PRIVATE ROAD)

Rolled Curbs Standard Sections

Exhibit 7E

Mountain Park Specific Plan (SP90-4, Amendment No. 1)

March 11, 2005

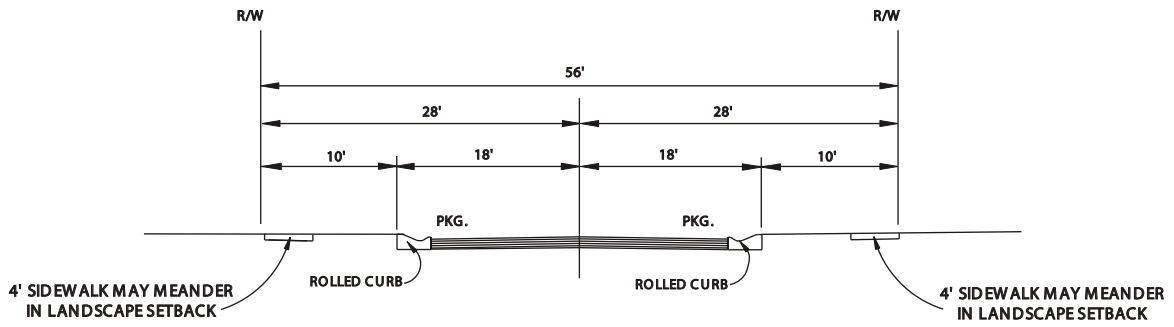

TYPICAL HILLSIDE INTERIOR STREET - PRIVATE

(Not Shown on Circulation Plan)

Typical Hillside Interior Street Section

Mountain Park Specific Plan (SP90-4, Amendment No. 1)

Exhibit 7F

March 11, 2005

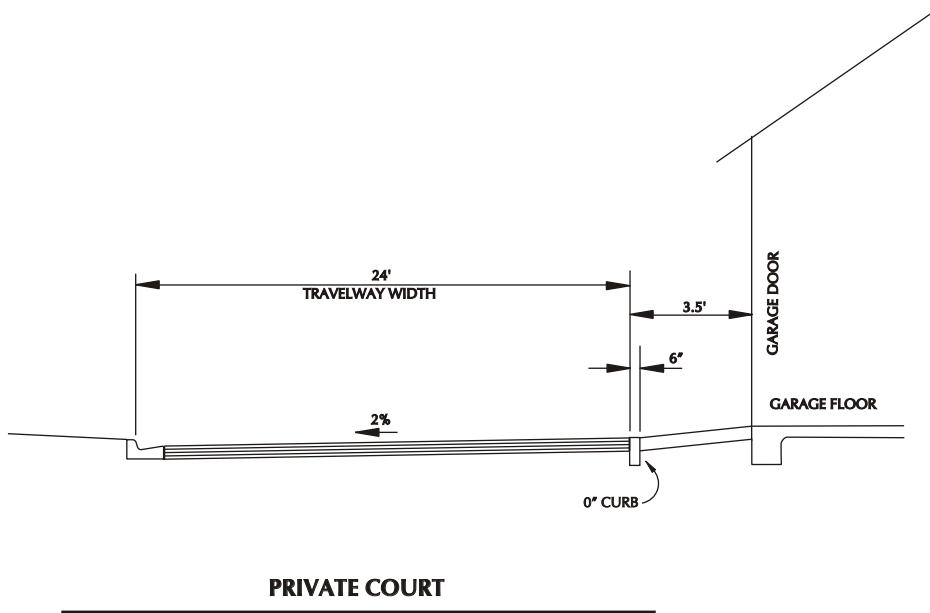
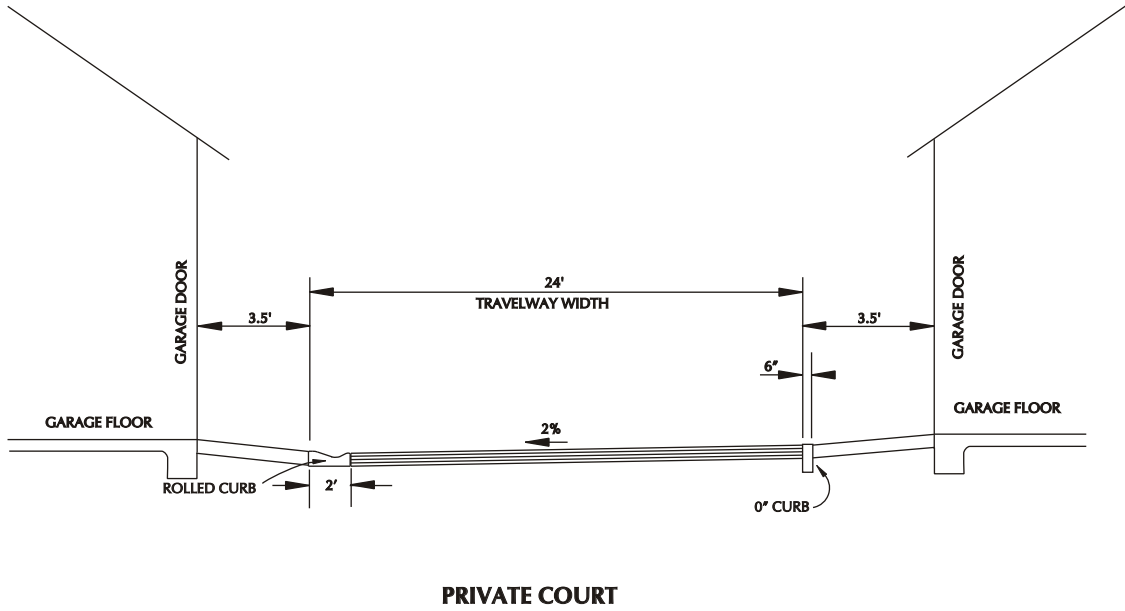

Typical Private Court Sections

Mountain Park Specific Plan (SP90-4, Amendment No. 1)

Exhibit 7G

March 11, 2005



Not To Scale

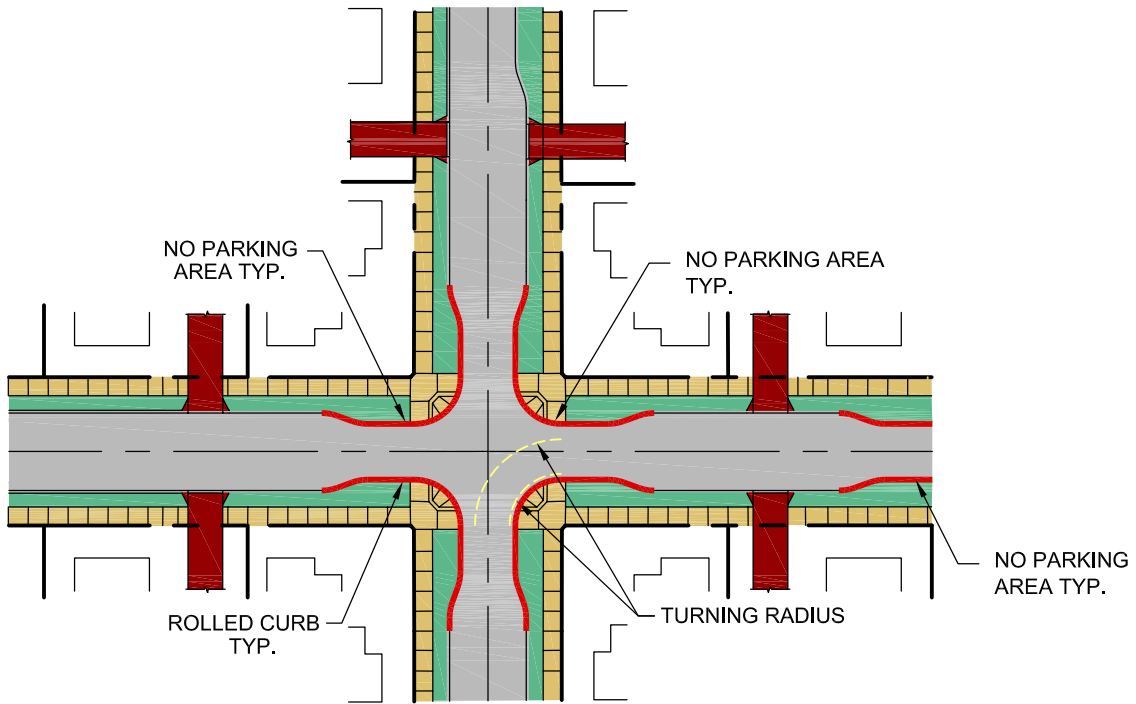

TYPICAL 4-WAY INTERSECTION
NOT TO SCALE

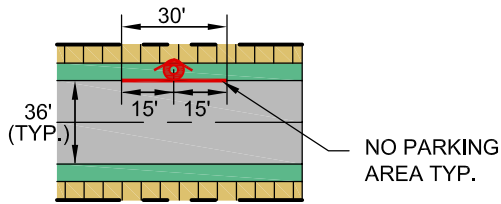



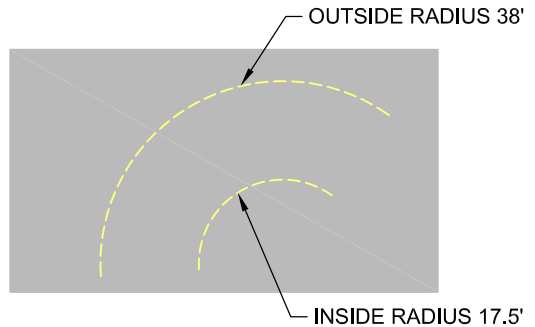

HYDRANT-NO PARKING
NOT TO SCALE



MINIMUM FIRE DEPARTMENT TURNING RADIUS
NOT TO SCALE

LEGEND:

-  STREET
-  SIDEWALK
-  DRIVEWAY
-  LANDSCAPED PARKWAY
-  NO PARKING AREA

Traffic Calming Features

Mountain Park Specific Plan (SP90-4, Amendment No. 1)

Exhibit 7H

March 11, 2005